

LONYUNG[®]
LED INTEGRATED LIGHT MANUFACTURER

LONYUNG LED LIGHTING CO.,LTD

Copyright © LONYUNG 2010-2020

LONYUNG[®]

LED INTEGRATED LIGHT MANUFACTURER

LONYUNG[®]
LED INTEGRATED LIGHT MANUFACTURER



COMPANY WEBSITE



PRODUCT MANUAL





Natural Light

Lonyung Better Light

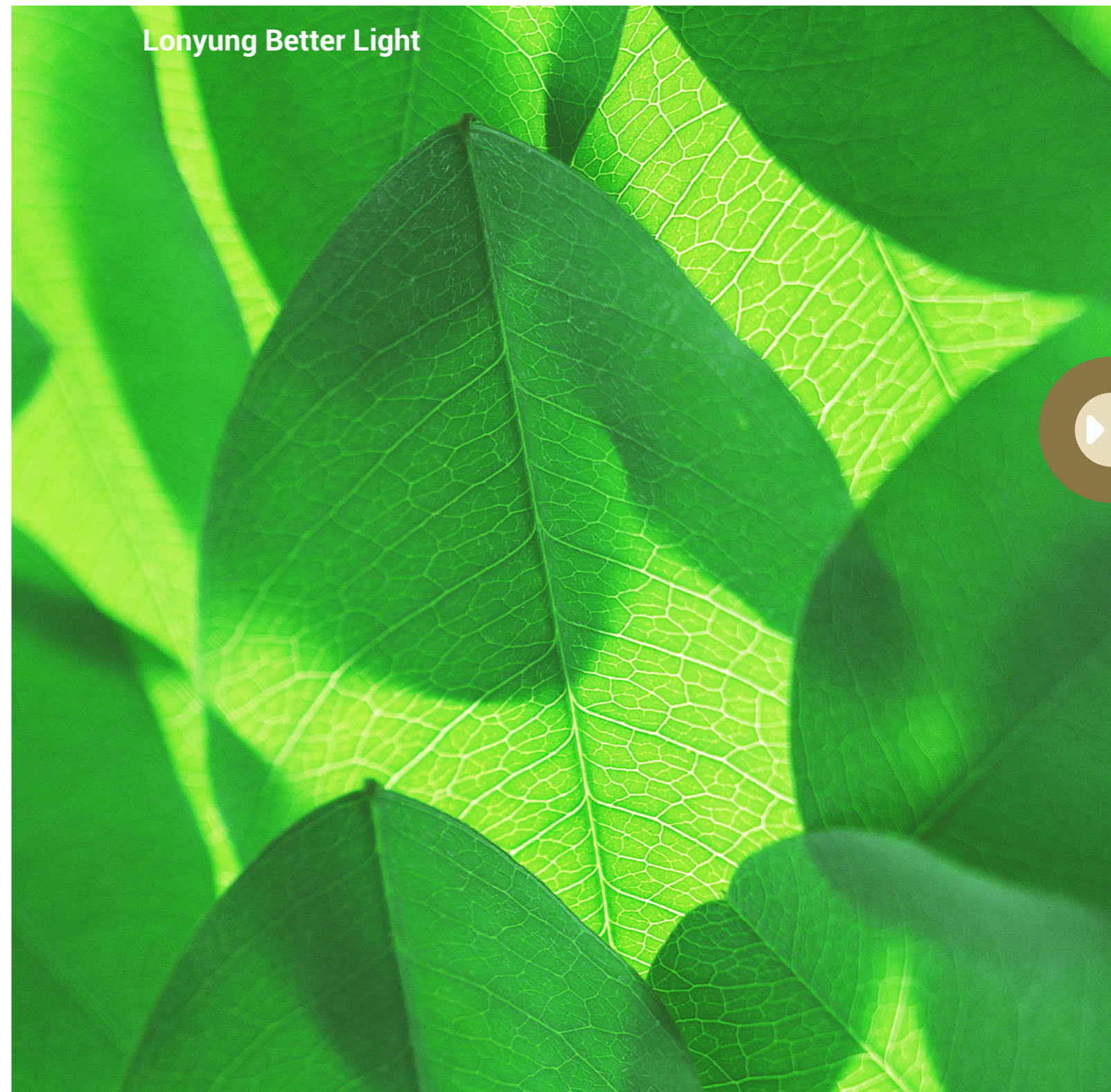

Lonyung Search



Content

LED INTEGRATED LIGHT MANUFACTURER

- L About Lonyung**
004-007
- O Featured Products**
008-017
- N Led Tri-proof Light Series**
018-025
- Y Led Integrated Light Series**
026-035
- U Professional Light Series**
036-047
- N High Bay Fixture Series**
048-053
- G Red Dot Award Product**
054-059

- L About Lonyung**
 - Lonyung Profile 004
 - Lonyung Family 005
 - Certifications 005
 - Company Culture 006-007

- O Featured Products**
 - Linear Led Trunking Light 008-009
 - Formable Led Fixture 010-011
 - 0-10V Dimming Led Integrated Light 012-013
 - Led Phantom Light 014-015
 - Led Strip Light 016-017

- N Led Tri-proof Light Series**
 - Led Tri-proof Light 018-019
 - Mini Led Tri-proof Light 020-021
 - Plastic Led Tri-proof Light 022-023
 - Plastic Led Integrated Light 024-025

- Y Led Integrated Light Series**
 - Single T5 Integrated Light (I) 026-027
 - Single T5 Integrated Light (II) 028-029
 - Double T5 Integrated Light (I) 030-031
 - Double T5 Integrated Light (II) 032-033
 - Led T8 Integrated Light 034-035

- U Professional Light Series**
 - Led Cabinet Light (I) 036-037
 - Led Cabinet Light (II) 038-039
 - Led Cooler Light 040-041
 - Led Batten Light (I) 042-043
 - Led Batten Light (II) 044-045
 - Led T8 Tube Light 046-047

- N High Bay Fixture Series**
 - High Bay Fixture (I) 048-049
 - High Bay Fixture (II) 050-051
 - Led Linear High Bay Fixture 052-053

- G Red Dot Award Product**
 - Led Pod Light 054-055
 - Led Camping Lantern 056-059



Lonyung Profile

Sine 2010

LONYUNG Led Lighting Co.,Ltd. is a high-tech enterprise specialized in the design, development, production and sales of LED lighting products. We were established in 2010 in Zhongshan City.

We are committed to promoting the application of LED lighting products and pay great attention to technological research and innovation. Until now, LONYUNG has obtained 69 patents and takes the lead in passing ISO9001 and BSCI. Our products are certificated under UL, ETL, DLC, TUV, CE, RoHS, SAA, Ip67, Ik10, FCC, PSE.

Our main products include LED integrated tube, LED tri-proof light, LED linear high bay light, LED cabinet light etc. They are widely used in office buildings, houses and industrial areas. We have successfully established long-term partnership with clients from North America, Europe, Australia.

LONYUNG team sincerely welcomes your OEM/ODM requirement. Quality is our spirit. We will always provide you excellent products and services at competitive and reasonable cost. We sincerely invite you to visit us.

Let's make success together.

Certifications

Energy Efficiency Certification



Until now, Lonyung has obtained more than 69 patents. At the same time, our products have approved safety certifications for North America, Europe, Australia and been rewarded with several Germany Red Dot Design Award.



Company Culture

Light Up Your Life



Because Of The Customer

Because the customer has a need,
we have a job to do.

/

Because the customer has a choice,
we must be the better choice.

/

Because the customer has sensibilities,
we must be considerate.

/

Because the customer has an urgency,
we must be quick.

/

Because the customer is unique,
we must be flexible.

/

Because the customer has high expectations,
we must excel.

/

Because the customer has influence,
we have the hope of more customer.

/

Because of the customer,
we exist!



Linear Led Trunking Light

One Power Source Connects All The Linked Fixture, Time Saving, Money Saving And Labor Saving



Features

- ✓ Seamless Connection
- ✓ Easy Installation
- ✓ Linkable To Max 1000w

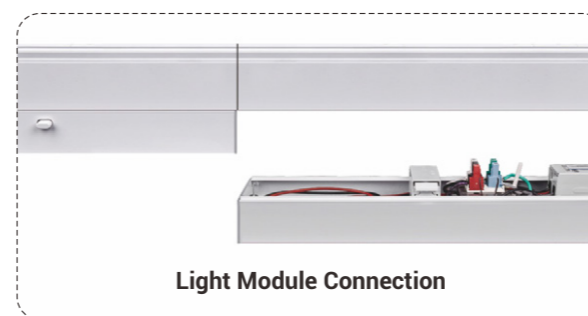
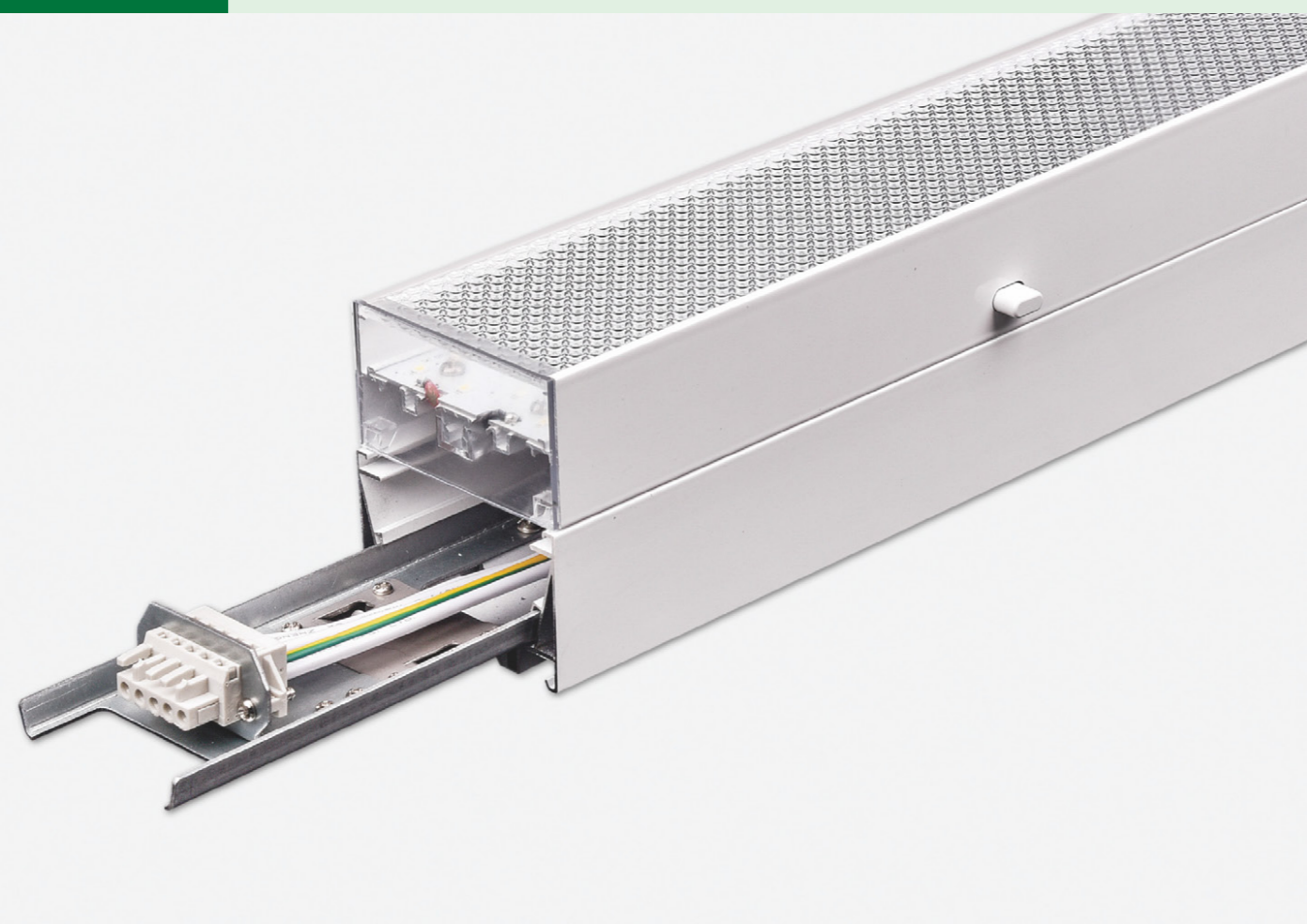

Product Line Drawing (Size:mm)

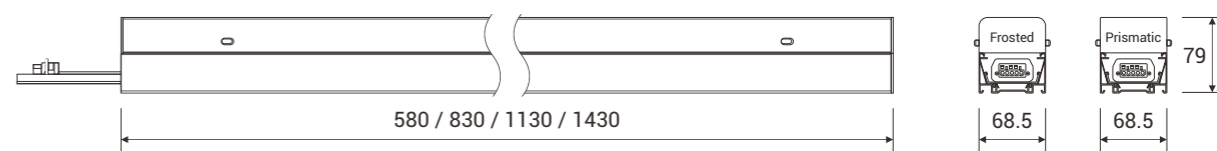

Product Specification

Material : AL+PC PC Cover : Frosted / Prismatic CCT : ■ 3000K ■ 4000K ■ 5000K ■ 6000K

Model	Size	Power	CRI	Package
LY-LS70L600-25W	2ft	25W	>80	915*300*230 (mm) 6pcs/ctn
LY-LS70L600-30W	2ft	30W	>80	915*300*230 (mm) 6pcs/ctn
LY-LS70L900-36W	3ft	36W	>80	1165*300*230 (mm) 6pcs/ctn
LY-LS70L900-45W	3ft	45W	>80	1165*300*230 (mm) 6pcs/ctn
LY-LS70L1200-48W	4ft	48W	>80	1465*300*230 (mm) 6pcs/ctn
LY-LS70L1200-60W	4ft	60W	>80	1465*300*230 (mm) 6pcs/ctn
LY-LS70L1500-60W	5ft	60W	>80	1765*205*230 (mm) 4pcs/ctn
LY-LS70L1500-75W	5ft	75W	>80	1765*205*230 (mm) 4pcs/ctn

- Trunk Rail Connection
- 5/7 Wire Trunk Rail
- L Node Connector
- T Node Connector
- + Node Connector



Applications: Supermarkets, Stores, Warehouses, Offices etc



Formable Led Fixture

Various Shape And Beam Angle Available According To Your Project Request



Features

- ☑ Deformable To Different Shape, Wattage And Beam Angle
- ☑ High Lumen Output
- ☑ Hassle-free, Safe And Easy Installation



••• Shape Optional

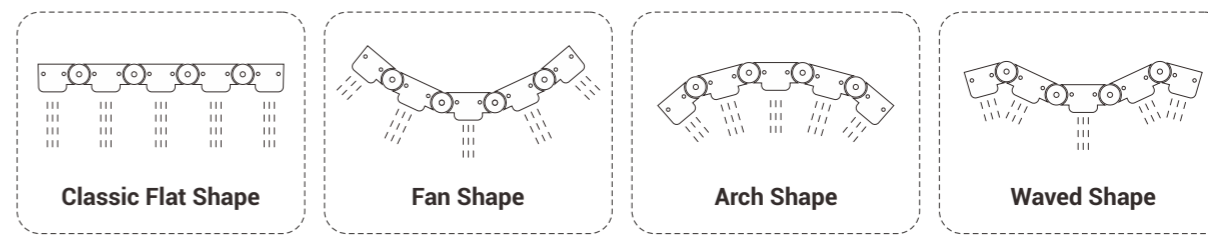

••• Product Line Drawing (Size:mm)

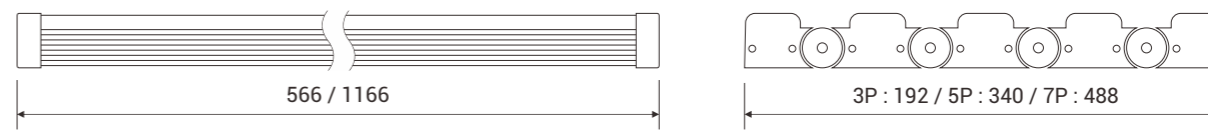

••• Product Specification

Material : AL+PC	PC Cover : Frosted / Clear	CCT : <input type="checkbox"/> 3000K <input type="checkbox"/> 4000K <input type="checkbox"/> 5000K <input type="checkbox"/> 6000K
-------------------------	-----------------------------------	--

Model	Size	Power	CRI	Package
LY-3PL600-45W	566*192*37 (mm)	45W	>80	745*210*225 (mm) 5pcs/ctn
LY-5PL600-75W	566*340*37 (mm)	75W	>80	705*220*365 (mm) 5pcs/ctn
LY-7PL600-105W	566*488*37 (mm)	105W	>80	705*220*510 (mm) 5pcs/ctn
LY-3PL1200-90W	1166*192*37 (mm)	90W	>80	1345*210*225 (mm) 5pcs/ctn
LY-5PL1200-150W	1166*340*37 (mm)	150W	>80	1305*220*365 (mm) 5pcs/ctn
LY-7PL1200-210W	1166*488*37 (mm)	210W	>80	1305*135*510 (mm) 3pcs/ctn

■ Shape Optional



••• **Applications:** Warehouses, Workshops, Storage, Factories, Gyms etc



0-10V Dimming Led Integrated Light

Fixed Forever Once Locked, Never Worry About Electricity Leaking



Features

- ✓ 0-10V Dimming
- ✓ Seamless Connection
- ✓ Self Locking Buckle Linkable



Self-locking Buckle Connection

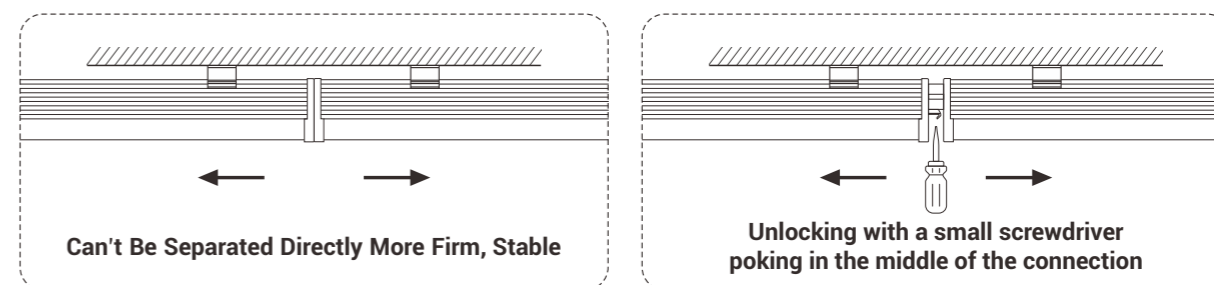

Product Line Drawing (Size:mm)

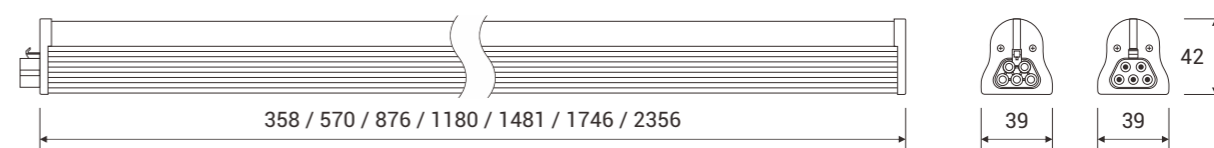

Product Specification

Material : AL+PC	PC Cover : Frosted / Clear	CCT : <input type="checkbox"/> 3000K <input type="checkbox"/> 4000K <input type="checkbox"/> 5000K <input type="checkbox"/> 6000K
------------------	----------------------------	---

Model	Size	Power	CRI	Beam Angle	Package
LY-T8DL300-5W	1ft	5W	>80	120	505*240*205 (mm) 20pcs/ctn
LY-T8DL600-9W	2ft	9W	>80	120	540*240*205 (mm) 20pcs/ctn
LY-T8DL900-13W	3ft	13W	>80	120	1140*240*205 (mm) 20pcs/ctn
LY-T8DL1200-18W	4ft	18W	>80	120	1440*240*205 (mm) 20pcs/ctn
LY-T8DL1200-22W	4ft	22W	>80	120	1440*240*205 (mm) 20pcs/ctn
LY-T8DL1500-25W	5ft	25W	>80	120	1740*240*205 (mm) 20pcs/ctn
LY-T8DL2400-44W	8ft	44W	>80	120	2610*150*166 (mm) 9pcs/ctn

Applications: Factories, Food Storage, Office Buildings, Hotels etc

Connection Ways



Power Cable



Standard Clip





Led Phantom Light

Perfect Replacement For The Led Cove Light



Features

- ✓ Ambient Decoration Indirect Lighting
- ✓ Cct Adjustable
- ✓ Triac Dimmable



■ Connection Ways

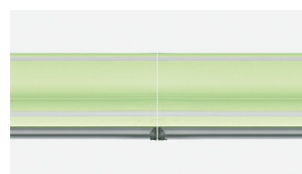

■ Straight Connector



■ Connecting Cable

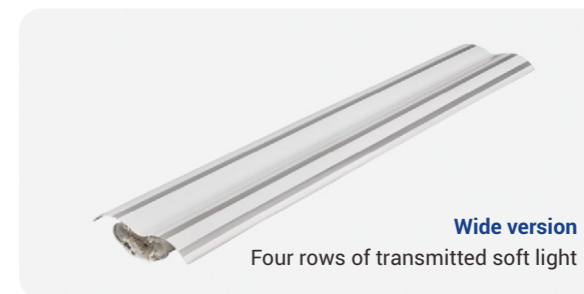
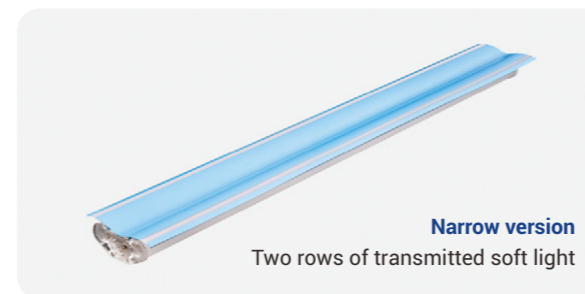

••• Product Line Drawing (Size:mm)

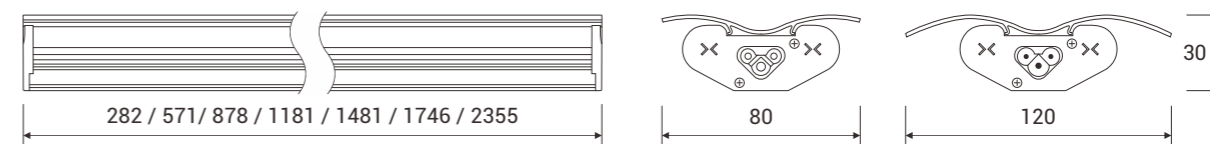

••• Product Specification

Material : PC	CCT : <input type="checkbox"/> 3000K <input type="checkbox"/> 4000K <input type="checkbox"/> 5000K <input type="checkbox"/> 6000K
---------------	---

Model	Size	Power	CRI	Package
LY-GYD80L300-3W	1ft	3W	>80	410*265*210 (mm) 10pcs/ctn
LY-GYD80L600-6W	2ft	6W	>80	700*265*210 (mm) 10pcs/ctn
LY-GYD80L900-9W	3ft	9W	>80	1010*265*210 (mm) 10pcs/ctn
LY-GYD80L1200-12W	4ft	12W	>80	1310*265*210 (mm) 10pcs/ctn
LY-GYD80L1500-15W	5ft	15W	>80	1610*265*210 (mm) 10pcs/ctn
LY-GYD80L1800-18W	6ft	18W	>80	1875*265*210 (mm) 10pcs/ctn
LY-GYD80L2400-24W	8ft	24W	>80	2485*265*210 (mm) 10pcs/ctn

••• Applications: Stair, Corridor, Hall, Decorative Lighting etc



Led Strip Light

More Economical, More Functional Extension



Features

- ✓ Color Temperature Tunable
- ✓ Detachable Lighting Fixture
- ✓ Connect Up To 600w



••• Installation

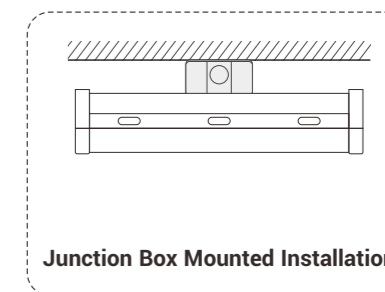
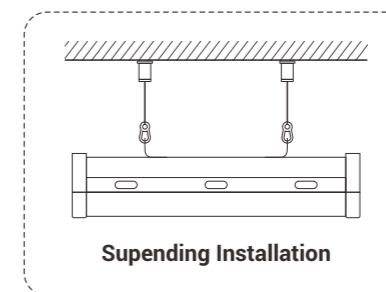
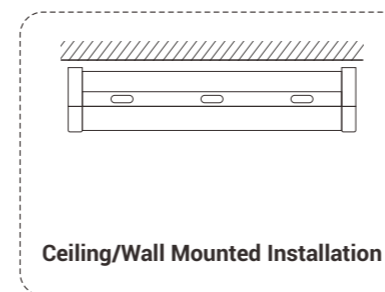

••• Product Line Drawing (Size:mm)

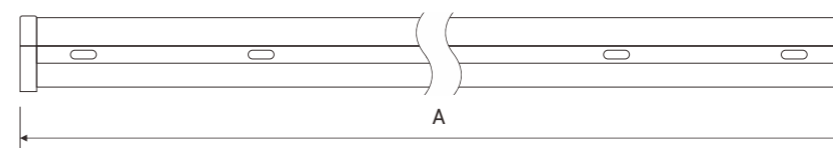
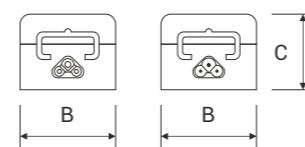

A	B	C
597	82.5	66
1197	82.5	66

••• Product Specification

Material : AL+PC	PC Cover : Frosted / Clear	CCT : <input type="checkbox"/> 3000K <input type="checkbox"/> 4000K <input type="checkbox"/> 5000K <input type="checkbox"/> 6000K
------------------	----------------------------	---

Model	Size	Power	CRI	Beam Angle	Package
LY-SF90L600-20W	2ft	20W	>80	120	690*190*235 (mm) 6pcs/ctn
LY-SF90L1200-40W	4ft	40W	>80	120	1290*190*235 (mm) 6pcs/ctn

- CCT Adjustable
- Drop-proof with safety rope
- Power entry from the back
- Junction-Box mounted



••• Applications: Work Areas, Shopping Mall, Office, Home etc



Led Tri-proof Light

Extremely Safe Lighting In Various Situations



Features

- ☑ Water-proof
- ☑ Dust-proof
- ☑ Pressure-proof



- Linkable
- Junction-Box mounted
- Suspending
- Standard Clip



Product Line Drawing (Size:mm)

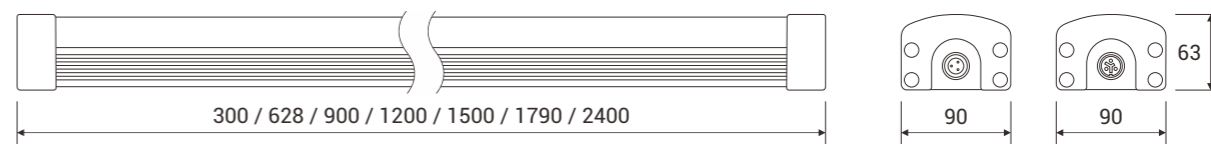

Product Specification

Material : AL+PC PC Cover : Frosted / Clear striped CCT : 3000K 4000K 5000K 6000K

Model	Size	Power	CRI	Beam Angle	Package
LY-SF90L300-20W	1ft	20W	>80	120	550*205*220 (mm) 6pcs/ctn
LY-SF90L600-30W	2ft	30W	>80	120	880*205*220 (mm) 6pcs/ctn
LY-SF90L900-40W	3ft	40W	>80	120	1150*205*220 (mm) 6pcs/ctn
LY-SF90L1200-60W	4ft	60W	>80	120	1450*205*220 (mm) 6pcs/ctn
LY-SF90L1500-80W	5ft	80W	>80	120	1750*205*220 (mm) 6pcs/ctn
LY-SF90L1800-90W	6ft	90W	>80	120	2040*205*155 (mm) 4pcs/ctn
LY-SF90L2400-120W	8ft	120W	>80	120	2650*110*155 (mm) 2pcs/ctn

Applications: Underground Parking Lot, Garage, Tunnel, Metro Station etc



Mini Led Tri-proof Light

Economic Solution For Led Tri-proof Light



Features

- ☑ Water-proof
- ☑ Dust-proof
- ☑ Connect Up To 600w



Product Line Drawing (Size:mm)

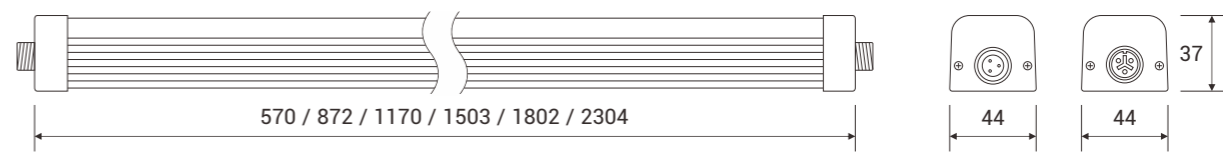

Product Specification

Material : AL+PC PC Cover : Frosted / Clear CCT : ■ 3000K ■ 4000K ■ 5000K ■ 6000K

Model	Size	Power	CRI	Beam Angle	Package
LY-T5SL600-15W(M)	2ft	15W	>80	120	710*260*180 (mm) 20pcs/ctn
LY-T5SL900-25W(M)	3ft	25W	>80	120	1015*260*180 (mm) 20pcs/ctn
LY-T5SL1200-30W(M)	4ft	30W	>80	120	1310*260*180 (mm) 20pcs/ctn
LY-T5SL1200-40W(M)	4ft	40W	>80	120	1310*260*180 (mm) 20pcs/ctn
LY-T5SL1500-40W(M)	5ft	40W	>80	120	1645*210*180 (mm) 16pcs/ctn
LY-T5SL1800-44W(M)	6ft	44W	>80	120	1945*210*180 (mm) 16pcs/ctn
LY-T5SL2400-60W(M)	8ft	60W	>80	120	2445*160*146 (mm) 9pcs/ctn

Applications: Warehouse, Airport, Factory, Indoor Stadium etc

■ Linkable

■ Non-Linkable

■ Connection Cable

■ Power Cord





Plastic Led Tri-proof Light

Your First Choice Of Linear Waterproof Fixture



Features

- ☑ Water-proof
- ☑ Dust-proof
- ☑ Corrosion-proof



■ Linkable



■ Non-Linkable



■ Standard Clip



Product Line Drawing (Size:mm)

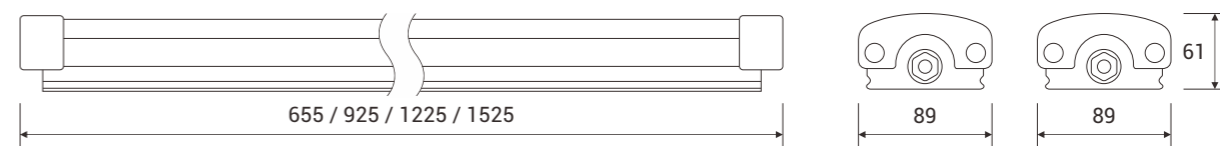

Wiring Method

Single Wired

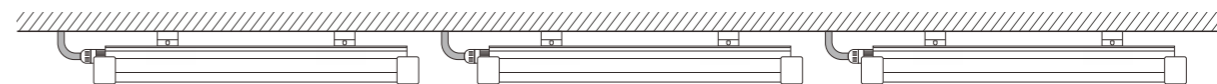

Linkable

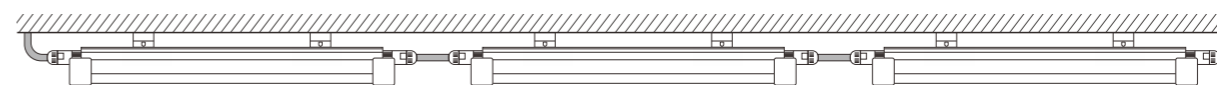

Product Specification

Material : PC	PC Cover : Frosted	CCT : ■ 3000K ■ 4000K ■ 5000K ■ 6000K
---------------	--------------------	---

Model	Size	Power	CRI	Beam Angle	Package
LY-SF90L600-20WP	2ft	20W	>80	120	800*300*150 (mm) 6pcs/ctn
LY-SF90L900-30WP	3ft	30W	>80	120	1070*300*150 (mm) 6pcs/ctn
LY-SF90L1200-40WP	4ft	40W	>80	120	1370*300*150 (mm) 6pcs/ctn
LY-SF90L1500-50WP	5ft	50W	>80	120	1670*300*150 (mm) 6pcs/ctn

Applications: Underground Parking Lot, Garage, Harbor, Tunnel, Metro Station etc

Plastic Led Integrated Light

Good Lighting Products, LONYUNG Created



Features

- ✓ Cost-Effective
- ✓ IP66 Rating
- ✓ 180° Beam Angle



Product Line Drawing (Size:mm)

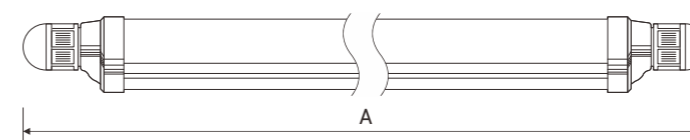
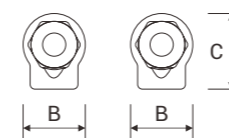

A	B	C
637	33	40
944	33	40
1247	33	40
1547	33	40

Product Specification

Material : PC	PC Cover : Frosted / Clear	CCT : ■ 3000K ■ 4000K ■ 5000K ■ 6000K
---------------	----------------------------	--

Model	Size	Power	CRI	Beam Angle	Package
LY-T8DL600-9WP	2ft	9W	>80	180	830*240*220 (mm) 25pcs/ctn
LY-T8DL900-13WP	3ft	13W	>80	180	1135*240*220 (mm) 25pcs/ctn
LY-T8DL1200-18WP	4ft	18W	>80	180	1440*240*220 (mm) 25pcs/ctn
LY-T8DL1500-22WP	5ft	22W	>80	180	1740*240*220 (mm) 25pcs/ctn

■ Linkable

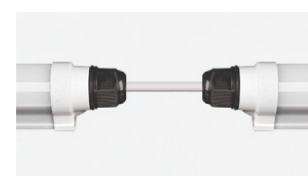

■ Non-Linkable

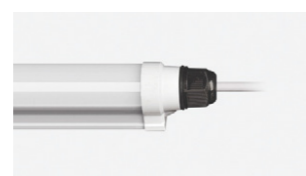

■ IP66 Connection



■ Standard Clip



••• Applications: Refrigerator, Fridge, Icebox, Cooler, Storeroom, Aquarium etc

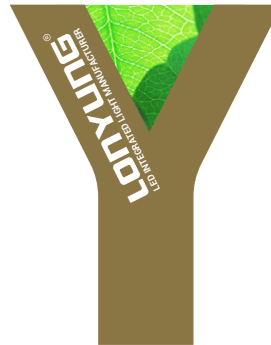

Single T5 Integrated Light (I)

Good Lighting Products, LONYUNG Created



Features

- ✓ Patent Male-female Linkable Design
- ✓ Seamless Connection
- ✓ Linkable Max 200w And 600w Optional



Product Line Drawing (Size:mm)

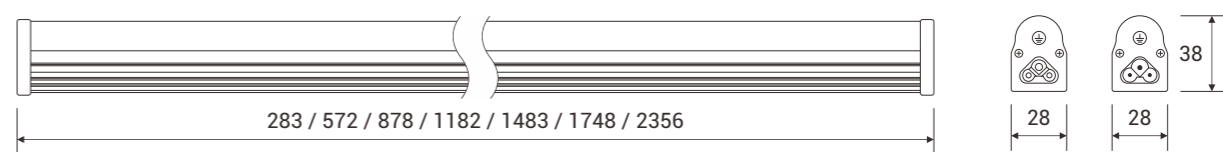

Product Specification

Material : AL+PC PC Cover : Frosted / Clear CCT : 3000K 4000K 5000K 6000K

Model	Size	Power	CRI	Beam Angle	Package
LY-T5DL300-4W	1ft	4W	>80	120	490*175*230 (mm) 25pcs/ctn
LY-T5DL600-7W	2ft	7W	>80	120	780*175*230 (mm) 25pcs/ctn
LY-T5DL900-12W	3ft	12W	>80	120	1085*175*230 (mm) 25pcs/ctn
LY-T5DL1200-15W	4ft	15W	>80	120	1390*175*230 (mm) 25pcs/ctn
LY-T5DL1500-20W	5ft	20W	>80	120	1690*175*230 (mm) 25pcs/ctn
LY-T5DL1800-22W	6ft	22W	>80	120	1955*175*190 (mm) 20pcs/ctn
LY-T5DL2400-30W	8ft	30W	>80	120	2565*175*145 (mm) 15pcs/ctn

Connection Ways



Connection Cable



Standard Clip



Applications: Restaurant, Store, Supermarket, Display Rack etc

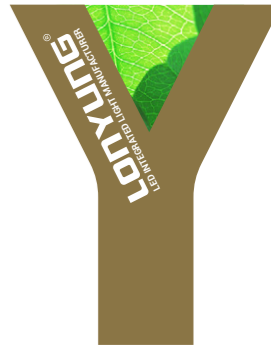

Single T5 Integrated Light (II)

Great Performance, Reasonable Cost



Features

- ✓ Patent Male-female Linkable Design
- ✓ Seamless Connection
- ✓ CCT Adjustable Optional



Product Line Drawing (Size:mm)

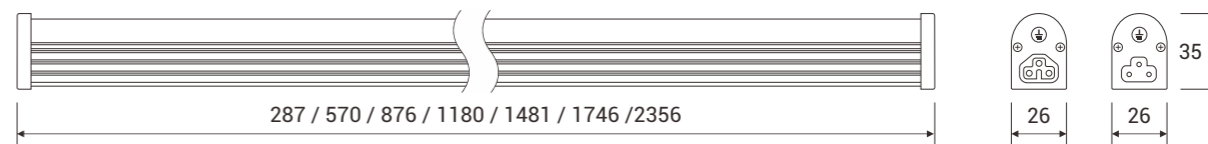

Product Specification

Material : AL+PC PC Cover : Frosted / Clear CCT : 3000K 4000K 5000K 6000K

Model	Size	Power	CRI	Beam Angle	Package
LY-T5DL300-4W	1ft	4W	>80	120	490*175*230 (mm) 25pcs/ctn
LY-T5DL600-7W	2ft	7W	>80	120	780*175*230 (mm) 25pcs/ctn
LY-T5DL900-12W	3ft	12W	>80	120	1085*175*230 (mm) 25pcs/ctn
LY-T5DL1200-15W	4ft	15W	>80	120	1390*175*230 (mm) 25pcs/ctn
LY-T5DL1500-20W	5ft	20W	>80	120	1690*175*230 (mm) 25pcs/ctn
LY-T5DL1800-22W	6ft	22W	>80	120	1955*175*190 (mm) 20pcs/ctn
LY-T5DL2400-30W	8ft	30W	>80	120	2565*175*145 (mm) 15pcs/ctn

Connection Ways

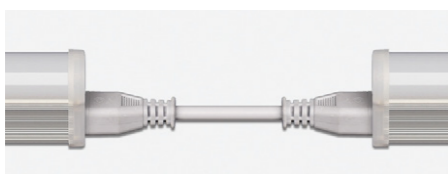

Straight Connector

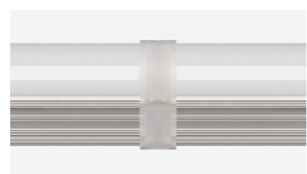

Standard Clip



Applications: Home, Hotel, Kitchen, Task Lighting etc

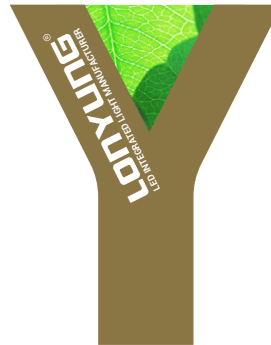

Double T5 Integrated Light (I)

Globally Original Double Tube Design, Elegant Appearance



Features

- ✓ Double Led Strip Design
- ✓ Excellent Brightness
- ✓ Linkable Max 200w And 600w Optional



■ Corner light



■ Standard Clip



Product Line Drawing (Size:mm)

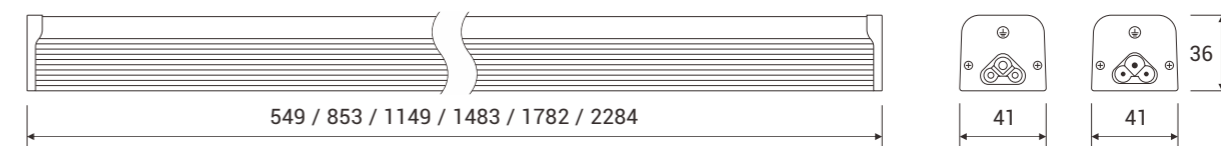

Product Specification

Material : AL+PC	PC Cover : Frosted / Clear	CCT : <input type="checkbox"/> 3000K <input type="checkbox"/> 4000K <input type="checkbox"/> 5000K <input type="checkbox"/> 6000K
------------------	----------------------------	---

Model	Size	Power	CRI	Beam Angle	Package
LY-T5SL600-15W	2ft	15W	>80	90 / 210	710*260*180 (mm) 20pcs/ctn
LY-T5SL900-25W	3ft	25W	>80	90 / 210	1015*260*180 (mm) 20pcs/ctn
LY-T5SL1200-30W	4ft	30W	>80	90 / 210	1310*260*180 (mm) 20pcs/ctn
LY-T5SL1200-40W	4ft	40W	>80	90 / 210	1310*260*180 (mm) 20pcs/ctn
LY-T5SL1500-40W	5ft	40W	>80	90 / 210	1645*210*180 (mm) 16pcs/ctn
LY-T5SL1800-44W	6ft	44W	>80	90 / 210	1945*210*180 (mm) 16pcs/ctn
LY-T5SL2400-60W	8ft	60W	>80	90 / 210	2445*160*146 (mm) 9pcs/ctn

Applications: Retail And Grocery Store, Warehouse, Factory, Workshop etc

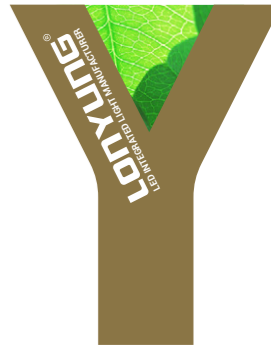

Double T5 Integrated Light (II)

Classical Integrative Original Design From LONYUNG



Features

- ✓ Double Led Strip Design
- ✓ More Flatter And Slimmer
- ✓ Greater Light Angle (>180° Beam)



■ Connection Ways



■ Standard Clip



Product Line Drawing (Size:mm)

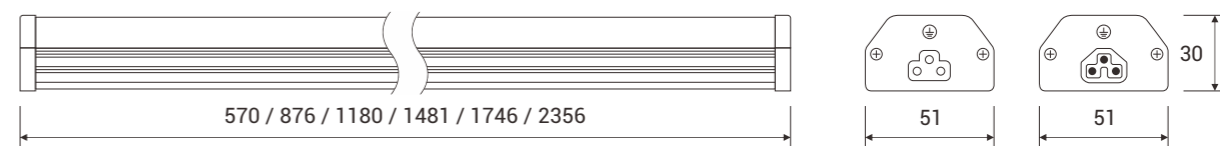

Wiring Method

Single Wired

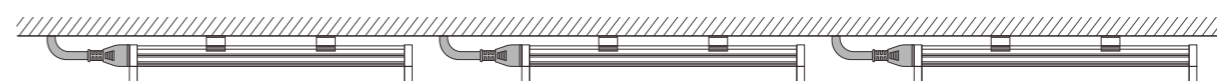

Linkable

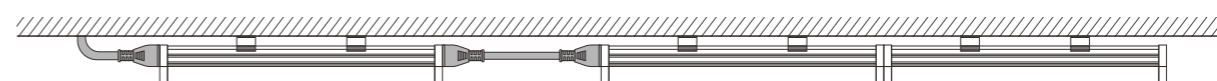

Product Specification

Material : AL+PC	PC Cover : Frosted / Clear	CCT : <input type="checkbox"/> 3000K <input type="checkbox"/> 4000K <input type="checkbox"/> 5000K <input type="checkbox"/> 6000K
------------------	----------------------------	---

Model	Size	Power	CRI	Beam Angle	Package
LY-T5SL600-15W	2ft	15W	>80	180	735*235*190 (mm) 20pcs/ctn
LY-T5SL900-25W	3ft	25W	>80	180	1045*235*190 (mm) 20pcs/ctn
LY-T5SL1200-30W	4ft	30W	>80	180	1345*235*190 (mm) 20pcs/ctn
LY-T5SL1200-40W	4ft	40W	>80	180	1345*235*190 (mm) 20pcs/ctn
LY-T5SL1500-40W	5ft	40W	>80	180	1645*235*155 (mm) 16pcs/ctn
LY-T5SL1800-44W	6ft	44W	>80	180	1910*235*155 (mm) 16pcs/ctn
LY-T5SL2400-60W	8ft	60W	>80	180	2520*180*120 (mm) 9pcs/ctn

Applications: Warehouse, Aisle, Shopping Center, Garage etc

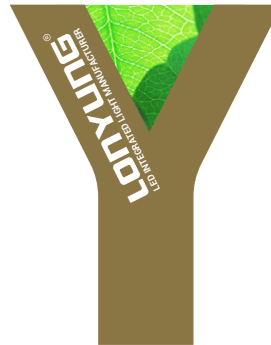

Led T8 Integrated Light

Classical Integrative Original Design From LONYUNG



Features

- ✓ Patent Male-female Linkable Design
- ✓ Seamless Connection
- ✓ Curved Lens Provides >120° Beam



Product Line Drawing (Size:mm)

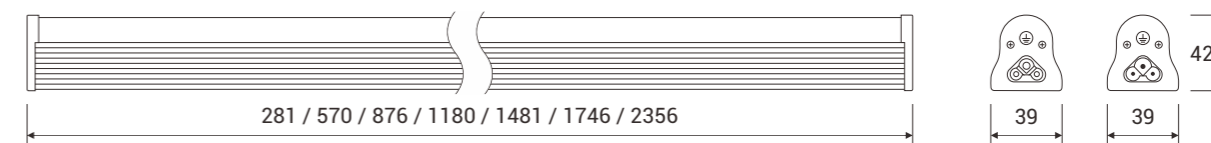

Product Specification

Material : AL+PC	PC Cover : Frosted / Clear	CCT : <input type="checkbox"/> 3000K <input type="checkbox"/> 4000K <input type="checkbox"/> 5000K <input type="checkbox"/> 6000K
------------------	----------------------------	---

Model	Size	Power	CRI	Beam Angle	Package
LY-T8DL300-5W	1ft	5W	>80	120	435*240*205 (mm) 20pcs/ctn
LY-T8DL600-9W	2ft	9W	>80	120	725*240*205 (mm) 20pcs/ctn
LY-T8DL900-13W	3ft	13W	>80	120	1035*240*205 (mm) 20pcs/ctn
LY-T8DL1200-18W	4ft	18W	>80	120	1335*240*205 (mm) 20pcs/ctn
LY-T8DL1200-22W	4ft	22W	>80	120	1335*240*205 (mm) 20pcs/ctn
LY-T8DL1500-25W	5ft	25W	>80	120	1640*240*205 (mm) 20pcs/ctn
LY-T8DL1800-28W	6ft	28W	>80	120	1900*240*205 (mm) 20pcs/ctn
LY-T8DL2400-44W	8ft	44W	>80	120	2510*150*166 (mm) 9pcs/ctn

Connection Ways



Corner Light



Standard Clip



Applications: Storage, Retail And Grocery Store, Parking Lot etc

Led Cabinet Light (I)

For Greater Kitchen Lighting Improvements



Features

- ✓ Easy Installation
- ✓ Seamless Connection
- ✓ Under Cabinet Lighting

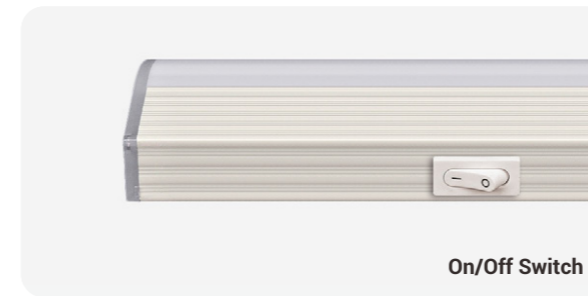

Product Line Drawing (Size:mm)

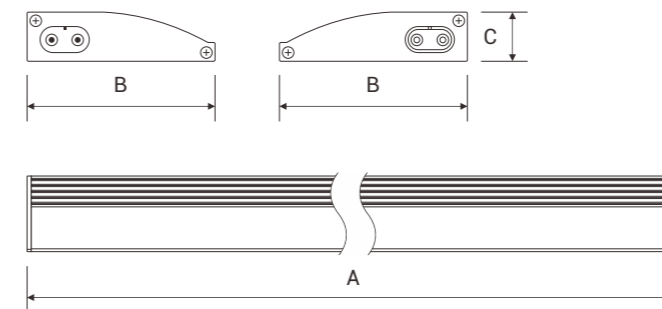

A	B	C
356	65	17
567	65	17
874	65	17
1177	65	17

Product Specification

Material : AL+PC	PC Cover : Frosted	CCT : <input type="checkbox"/> 3000K <input type="checkbox"/> 4000K <input type="checkbox"/> 5000K <input type="checkbox"/> 6000K
------------------	--------------------	---

Model	Size	Power	CRI	Package
LY-CG65L300-4W	1ft	4W	>80	540*165*250 (mm) 20pcs/ctn
LY-CG65L600-7W	2ft	7W	>80	750*165*250 (mm) 20pcs/ctn
LY-CG65L900-12W	3ft	12W	>80	1060*165*250 (mm) 20pcs/ctn
LY-CG65L1200-15W	4ft	15W	>80	1360*165*250 (mm) 20pcs/ctn
LY-CG65L1200-20W	4ft	20W	>80	1360*165*250 (mm) 20pcs/ctn

- Seamless Connection
- Connecting Cable
- Straight Connector



Applications: Under And Over Cabinets, Display Cases, Task Lighting, Work Areas etc



Led Cabinet Light (II)

Square Design, Light Up Your Life



Features

- ☑ Square Design
- ☑ Seamless Connection
- ☑ Under Cabinet Lighting

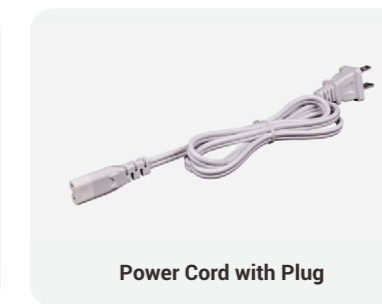
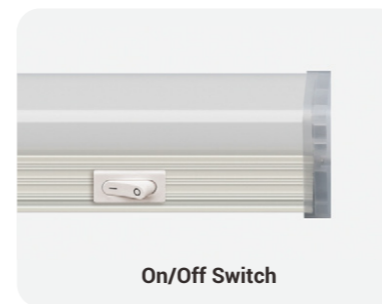

Product Line Drawing (Size:mm)

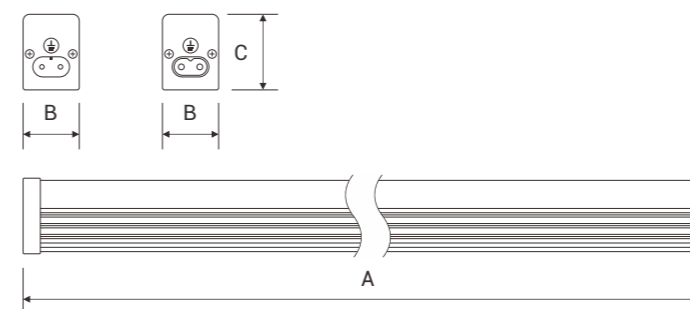

A	B	C
360	26	35
571	26	35
878	26	35
1181	26	35

Product Specification

Material : AL+PC	PC Cover : Frosted / Clear	CCT : <input type="checkbox"/> 3000K <input type="checkbox"/> 4000K <input type="checkbox"/> 5000K <input type="checkbox"/> 6000K
------------------	----------------------------	---

Model	Size	Power	CRI	Beam Angle	Package
LY-T5FL300-4W	1ft	4W	>80	120	490*200*230 (mm) 20pcs/ctn
LY-T5FL600-7W	2ft	7W	>80	120	780*200*230 (mm) 20pcs/ctn
LY-T5FL900-12W	3ft	12W	>80	120	1085*200*230 (mm) 20pcs/ctn
LY-T5FL1200-15W	4ft	15W	>80	120	1390*200*230 (mm) 20pcs/ctn
LY-T5FL1200-20W	4ft	20W	>80	120	1390*200*230 (mm) 20pcs/ctn

- Connection
- Connecting Cable
- Straight Connector
- Standard Clip



Applications: Under And Over Cabinets, Display Cases, Task Lighting, Work Areas etc



Led Cooler Light

Best Solutions For Freezer, Cooler



Features

- ☑ Moisture-proof
- ☑ V-shaped Design
- ☑ Greater Light Angle 270° Beam



■ Non-Linkable



■ Linkable



■ IP66 Connection



■ V-shaped Design



Product Line Drawing (Size:mm)

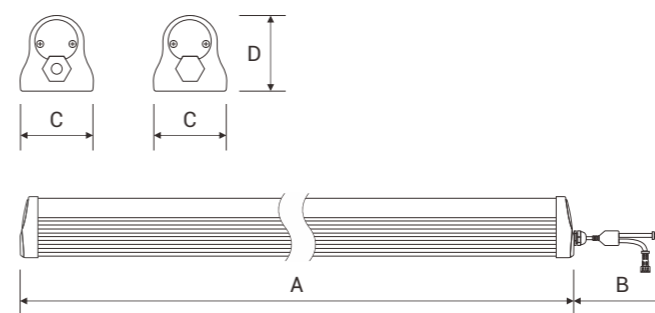

A	B	C	D
1192	750	40	42
1493	750	40	42
1758	750	40	42

■ Easy Daisy-Chain Installation

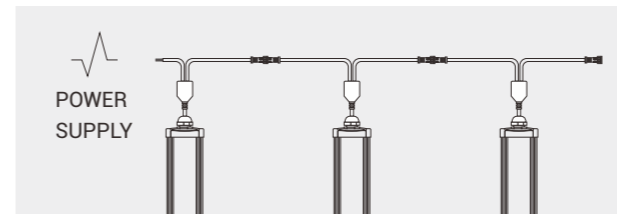

■ one Cable With Two Output

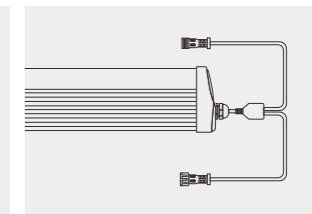

■ Beam Angle

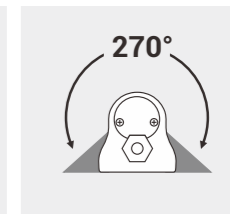

Product Specification

Material : AL+PC	PC Cover : Frosted / Clear	CCT : <input type="checkbox"/> 3000K <input type="checkbox"/> 4000K <input type="checkbox"/> 5000K <input type="checkbox"/> 6000K
------------------	----------------------------	---

Model	Size	Power	CRI	Beam Angle	Package
LY-T8DL1200-22W	4ft	22W	>80	270	1640*240*205 (mm) 20pc/ctn
LY-T8DL1500-25W	5ft	25W	>80	270	1715*240*205 (mm) 20pc/ctn
LY-T8DL1800-28W	6ft	28W	>80	270	1975*240*205 (mm) 20pc/ctn

Applications: Upright Refrigerator, Freezer, Fridge etc



Led Batten Light (I)

Elegant Design, Unique 3 Rows Light



Features

- ✓ Batten Lampshade
- ✓ Smooth And Uniform Light
- ✓ Seamless / No-dark Connection



- Seamless Connection
- CCT Adjustable
- On/Off Switch
- Straight Connector

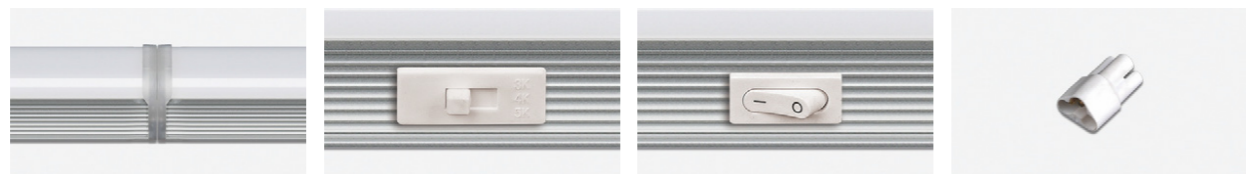

Product Line Drawing (Size:mm)

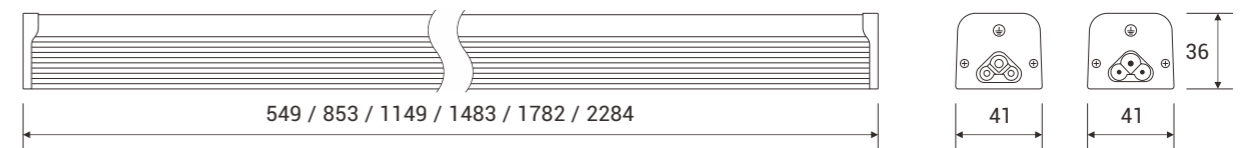

Wiring Method

Single Wired

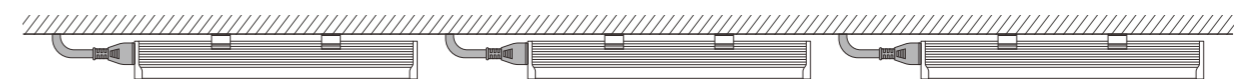

Linkable

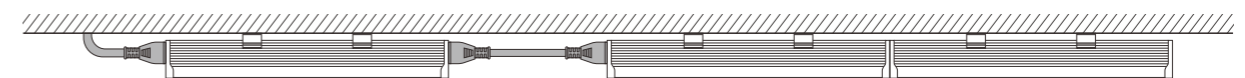

Product Specification

Material : AL+PC	PC Cover : Frosted / Clear	CCT : <input type="checkbox"/> 3000K <input type="checkbox"/> 4000K <input type="checkbox"/> 5000K <input type="checkbox"/> 6000K
------------------	----------------------------	---

Model	Size	Power	CRI	Beam Angle	Package
LY-T5SL600-15W	2ft	15W	>80	120	710*260*180 (mm) 20pcs/ctn
LY-T5SL900-25W	3ft	25W	>80	120	1015*260*180 (mm) 20pcs/ctn
LY-T5SL1200-30W	4ft	30W	>80	120	1310*260*180 (mm) 20pcs/ctn
LY-T5SL1200-40W	4ft	40W	>80	120	1310*260*180 (mm) 20pcs/ctn
LY-T5SL1500-40W	5ft	40W	>80	120	1645*210*180 (mm) 16pcs/ctn
LY-T5SL1800-44W	6ft	44W	>80	120	1945*210*180 (mm) 16pcs/ctn
LY-T5SL2400-60W	8ft	60W	>80	120	2445*160*146 (mm) 9pcs/ctn

Applications: Commercial Buidling, Library, Lobby, Hall etc

Led Batten Light (II)

Quality Interior Lighting Luminaire



Features

- ✓ Smooth And Uniform Light
- ✓ Excellent Brightness
- ✓ Connect Up To 600w



Product Line Drawing (Size:mm)

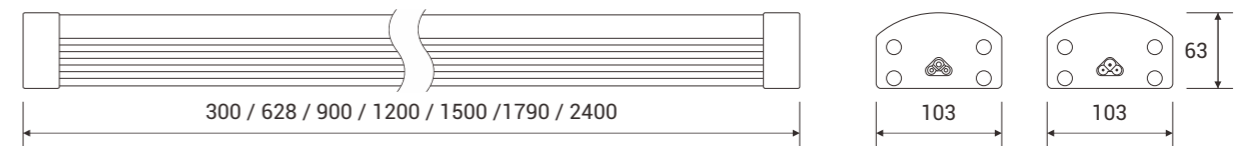

Product Specification

Material : AL+PC	PC Cover : Frosted / Clear	CCT : <input type="checkbox"/> 3000K <input type="checkbox"/> 4000K <input type="checkbox"/> 5000K <input type="checkbox"/> 6000K
------------------	----------------------------	---

Model	Size	Power	CRI	Beam Angle	Package
LY-SF90L300-20W	1ft	20W	>80	120	435*240*230 (mm) 6pcs/ctn
LY-SF90L600-30W	2ft	30W	>80	120	735*240*230 (mm) 6pcs/ctn
LY-SF90L900-40W	3ft	40W	>80	120	1005*240x230 (mm) 6pcs/ctn
LY-SF90L1200-60W	4ft	60W	>80	120	1305*240*230 (mm) 6pcs/ctn
LY-SF90L1500-80W	5ft	80W	>80	120	1605*240*230 (mm) 6pcs/ctn
LY-SF90L1800-90W	6ft	90W	>80	120	1895*125*160 (mm) 4pcs/ctn
LY-SF90L2400-120W	8ft	120W	>80	120	2505*125*160 (mm) 2pcs/ctn

Connection Ways



In-Line Connector



Standard Clip



Applications: 4S, Indoor Stadium, Car parks & Sports Facilities, Gymnasium etc

Led T8 Tube Light

Classical Product, Global Reputation



Features

- ☑ Replacement Traditional Fluorescent T8 And T12 Lighting
- ☑ Energy Savings More Than 60%
- ☑ 0.8mm Aluminum Housing



■ G13



■ Rotatable G13



■ R17D



■ Fa8



■ T8 To T5



Product Line Drawing (Size:mm)

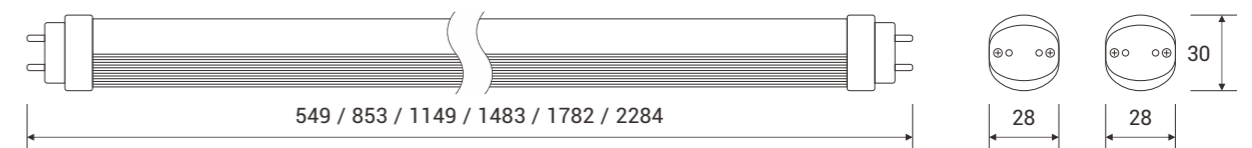

Connection Ways

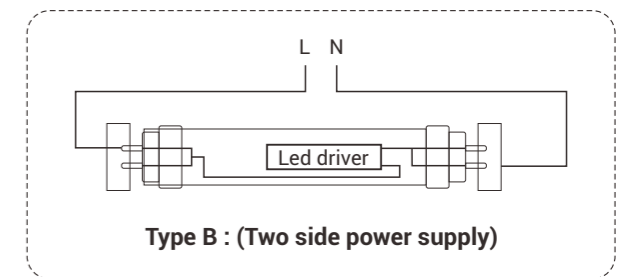
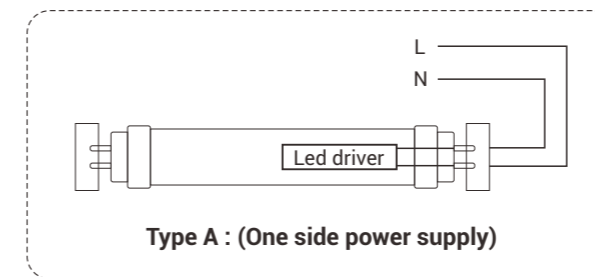

Product Specification

Material : AL+PC	PC Cover : Frosted / Clear	CCT : <input type="checkbox"/> 3000K <input type="checkbox"/> 4000K <input type="checkbox"/> 5000K <input type="checkbox"/> 6000K
------------------	----------------------------	---

Model	Size	Power	CRI	Beam Angle	Package
LY-T8L600-9W	2ft	9W	>80	120	665*340*200 (mm) 50pcs/ctn
LY-T8L900-13W	3ft	13W	>80	120	970*340*200 (mm) 50pcs/ctn
LY-T8L1200-16W	4ft	16W	>80	120	1280*275*200 (mm) 40pcs/ctn
LY-T8L1200-18W	4ft	18W	>80	120	1280*275*200 (mm) 40pcs/ctn
LY-T8L1500-22W	5ft	22W	>80	120	1580*210*200 (mm) 30pcs/ctn
LY-T8L1800-28W	6ft	28W	>80	120	1840*210*200 (mm) 30pcs/ctn
LY-T8L2400-44W	8ft	44W	>80	120	2455*175*165 (mm) 20pcs/ctn

Applications: Supermarkets, Shopping Mall, Entertainment Venues, Factories etc



High Bay Fixture (I)

Heavy Duty, Light Up The World



Features

- ✓ Better Light Utilization By Optical Lens
- ✓ 1.3mm Aluminum Housing
- ✓ Ip65 Water-proof & Dust-proof



••• Installation Ways

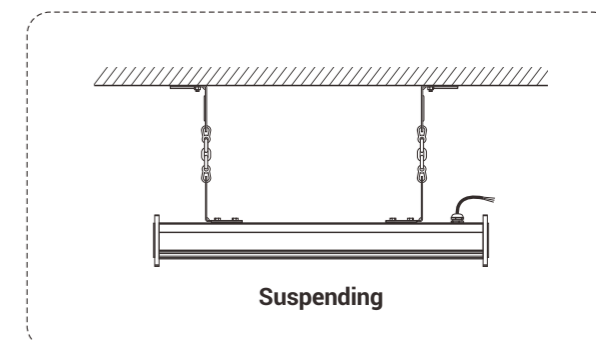
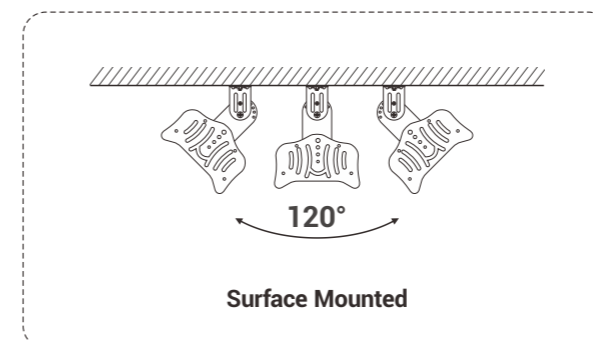

••• Product Line Drawing (Size:mm)

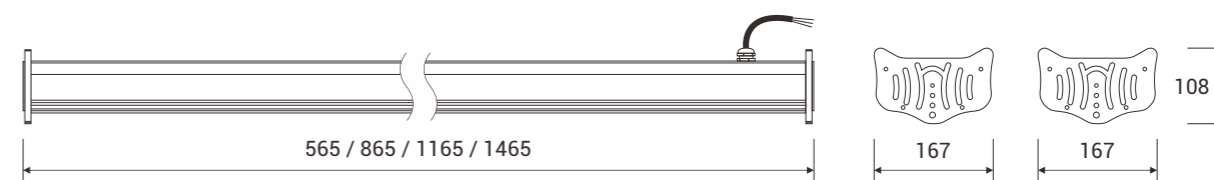

••• Product Specification

Material : AL+PC	PC Cover : Lens	CCT : <input type="checkbox"/> 3000K <input type="checkbox"/> 4000K <input type="checkbox"/> 5000K <input type="checkbox"/> 6000K
------------------	-----------------	---

Model	Size	Power	CRI	Package
LY-HB180L600-100W/120W	2ft	100W/120W	>80	655*195*160 (mm) 1pc/ctn
LY-HB180L900-150W/180W	3ft	150W/180W	>80	955*195*160 (mm) 1pc/ctn
LY-HB180L1200-200W/240W	4ft	200W/240W	>80	1255*195*160 (mm) 1pc/ctn
LY-HB180L1500-200W/240W	5ft	200W/240W	>80	1555*195*160 (mm) 1pc/ctn

■ Power Cable



■ Accessories

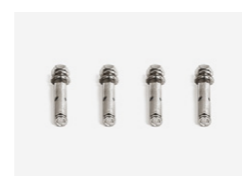

••• Applications: Warehouses, Food storage, Tunnel, Basement etc



High Bay Fixture (II)

Compact Tough, Reliable And Safety



Features

- ✓ Wider Luminous Area
- ✓ 1.3mm Aluminum Housing
- ✓ IP65 Water-proof & Dust-proof



••• Installation Ways

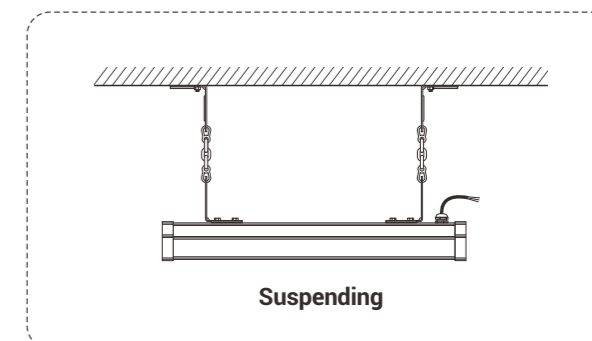
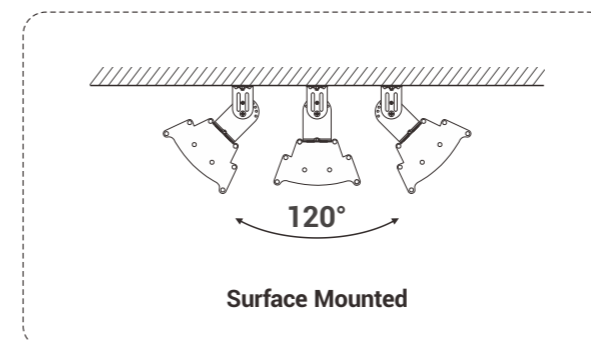

••• Product Line Drawing (Size:mm)

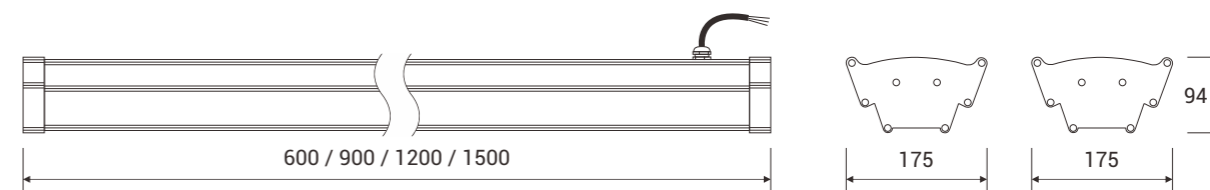

••• Product Specification

Material : AL+PC	PC Cover : Frosted / Clear	CCT : <input type="checkbox"/> 3000K <input type="checkbox"/> 4000K <input type="checkbox"/> 5000K <input type="checkbox"/> 6000K
------------------	----------------------------	---

Model	Size	Power	CRI	Package
LY-HB180L600-100W/120W	2ft	100W/120W	>80	655*220*190 (mm) 1pc/ctn
LY-HB180L900-150W/180W	3ft	150W/180W	>80	955*220*190 (mm) 1pc/ctn
LY-HB180L1200-200W/240W	4ft	200W/240W	>80	1255*220*190 (mm) 1pc/ctn
LY-HB180L1500-200W/240W	5ft	200W/240W	>80	1555*220*190 (mm) 1pc/ctn

■ Power Cable



■ Accessories

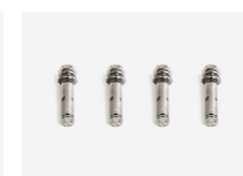

••• Applications: Workshop, Cold Storage, Facilities, Railway, Train Station etc



Led Linear High Bay Fixture

Excellent Manufacturing Quality, Used In Large-scale Public Places



Features

- ✓ High Output 140LM/W
- ✓ Large Luminous Area
- ✓ Easy Installation With Lower Cost



Product Line Drawing (Size:mm)

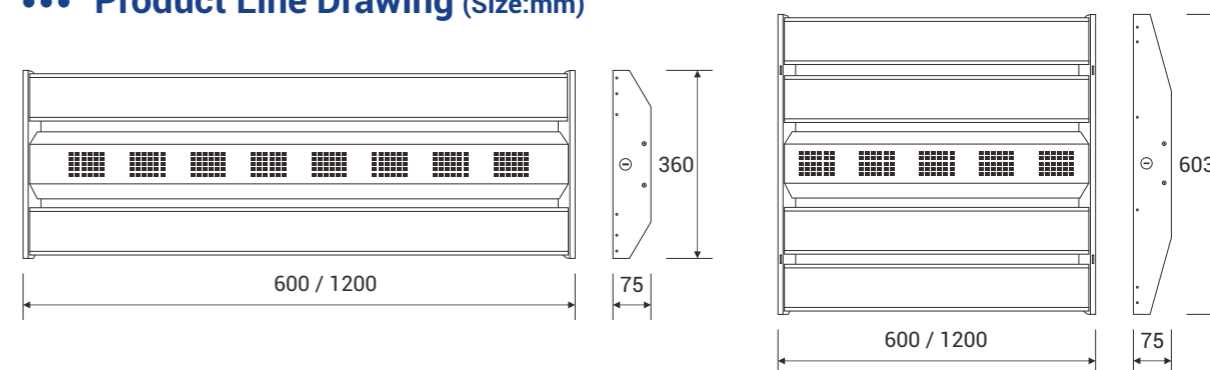

Product Specification

Material : AL+PC	PC Cover : Prism	CCT : <input type="checkbox"/> 3000K <input type="checkbox"/> 4000K <input type="checkbox"/> 5000K <input type="checkbox"/> 6000K
------------------	------------------	---

Model	Size	Power	CRI	Package
LY-HB300L600-80WP	1x2ft	80W	>80	650*430*250 (mm) 2pcs/ctn
LY-HB300L600-100WP	1x2ft	100W	>80	650*430*250 (mm) 2pcs/ctn
LY-HB300L1200-165WP	1x4ft	165W	>80	1210*425*250 (mm) 2pcs/ctn
LY-HB600L600-200WP	2x2ft	200W	>80	640*660*230 (mm) 2pcs/ctn
LY-HB600L1200-320WP	2x4ft	320W	>80	1210*660*220 (mm) 2pcs/ctn

Connection



Standard Accessories

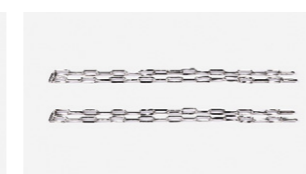

Applications: Workshop, Warehouse, Storage, Plant, Sports Stadium etc

Led Pod Light



reddot award 2017
honourable mention



Led Camping Lantern



reddot award 2016
winner

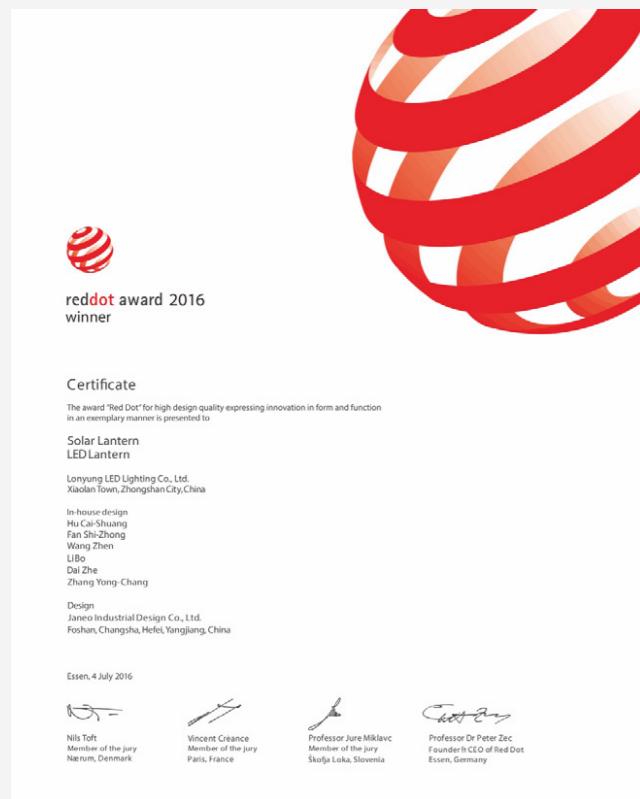



Led Camping Lantern

Reddot Product Design Award, Cute Gift



Features

- ☑ Shatter-resistant
- ☑ IP67 Waterproof
- ☑ USB Charging



- 100% Lighting
- 20% Lighting
- Mosquito Repellent
- SOS
- IP67

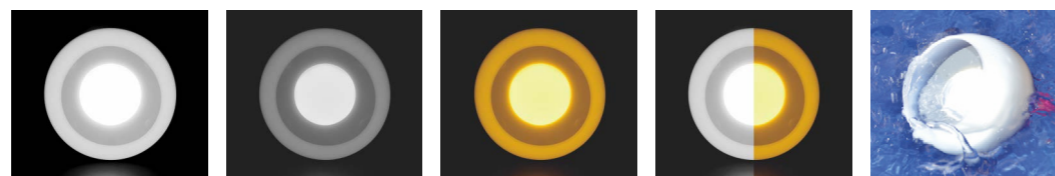

... Charge Mode



... Lighting

The Max. Luminous Flux of 100% Lighting	≥100Lm
The Max. Luminous Flux of 20% Lighting	≥20Lm
100% Lighting time after fully charged	≥4hours
20% Lighting time after fully charged	≥7hours

... Specification

Input Voltage	5.2V	Input Current	200MA
Fully Charged Time	2Hours	Product Size	φ 80x70mm
Product Weight	102g±1g	Battery	1000mAH Li-ion Battery
Package	425x355x380mm 80pcs/ctn		

LONYUNG®
LED INTEGRATED LIGHT MANUFACTURER

LONYUNG LED LIGHTING CO.,LTD

Tel: 86-760-2218 2786

Fax: 86-760-2383 2030

E-mail: info@lonyung.com

Address: Block2, number 39, East Jucheng Rd, Xiaolan
Town, Zhongshan City, China

[Https://www.lonyung.com](https://www.lonyung.com)

[Https://www.lonyung.com.cn](https://www.lonyung.com.cn)

[Https://www.lonyunglighting.com](https://www.lonyunglighting.com)

[Https://www.lonyung.en.alibaba.com](https://www.lonyung.en.alibaba.com)

[Https://www.lonyungled.en.alibaba.com](https://www.lonyungled.en.alibaba.com)

[Https://www.lonyunglighting.en.alibaba.com](https://www.lonyunglighting.en.alibaba.com)

[Https://zslonyung.1688.com](https://zslonyung.1688.com)

Lonyung

Copyright © LONYUNG 2010-2020