



## 3FM8A (6V8Ah)

**LONGWAY®** Standard battery is design for a general purpose by KaiYing Power. 3FM8 is a general purpose battery up to 5 years in float service or more than 260 cycles at 100% discharge in cycle service. As with all **LONGWAY®** batteries, all are rechargeable highly efficient, leak proof and maintenance free.



ISO 9001:2008 Standard



ISO 14001:2004 Standard



### Specifications:

Cells per Unit	3
Normal Voltage	6V
Capacity	8Ah@20Hr-rate to 1.75V per cell@25°C
Weight	Approx. (1.4±3%)kg(3.09lbs)
Maximum Discharge Current	80A(5sec)
Internal Resistance	Approx. 15mΩ full charged @25°C
Operating Temperature Range	Discharge: -20°C~60°C Charge: 0°C~50°C Storage: -20°C~60°C
Nominal Operating Temperature Range	25°C±3°C
Float Charging Voltage	6.75~6.9VDC/unit Average @25°C
Maximum Charging Current	2.4A
Equalization and Cycle Service	7.20V~7.50VDC/unit Average @ 25°C
Self Discharge	LONGWAY Valve Regulated Lead Acid (VRLA) batteries can be stored for more than 6 months at 25°C. Self-discharge ratio less than 3% per month at 25°C. Please charge batteries before using.
Terminal	F1(0.187)/F2(0.250)
Container Material	ABS(UL94-HB) *Flammability resistance of (UL94-V0) can be available upon request

### Dimensions: L98\*W56\*H115(TH115)mm

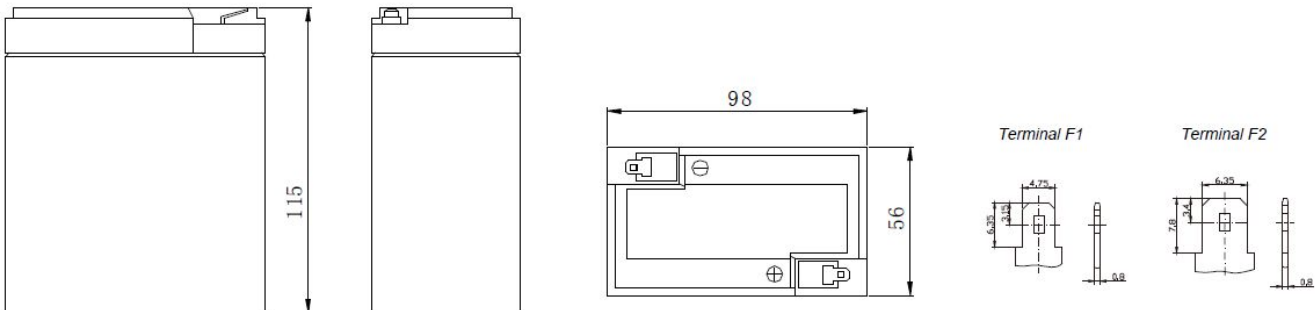

### Constant Current Discharge Characteristics (A, 25 °C)

F.V/TIME	5min	10min	15min	30min	60min	2h	3h	5h	8h	10h	20h
4.80	34.00	23.04	17.84	8.800	5.200	2.923	2.192	1.380	0.893	0.755	0.406
4.95	32.98	22.35	17.30	8.536	5.044	2.894	2.171	1.367	0.889	0.751	0.404
5.10	32.30	21.89	17.13	8.448	4.992	2.880	2.160	1.360	0.885	0.748	0.402
5.25	31.28	21.20	16.41	8.096	4.784	2.851	2.138	1.346	0.882	0.745	0.401
5.40	30.36	20.57	16.27	8.026	4.742	2.822	2.117	1.333	0.880	0.744	0.400

### Constant Power Discharge Characteristics (Watt, 25 °C)

F.V/TIME	5min	10min	15min	30min	60min	2h	3h	5h	8h	10h	20h
4.80	189.7	129.9	101.69	50.42	30.11	17.10	13.02	8.24	5.359	4.531	2.436
4.95	184.0	126.0	98.64	48.91	29.20	16.93	12.89	8.16	5.333	4.509	2.424
5.10	180.2	123.4	97.62	48.41	28.90	16.85	12.83	8.12	5.312	4.491	2.414
5.25	174.5	119.5	93.55	46.39	27.70	16.68	12.70	8.04	5.291	4.473	2.405
5.40	169.4	116.0	92.74	45.99	27.46	16.51	12.57	7.96	5.280	4.464	2.400

### Float Service Life

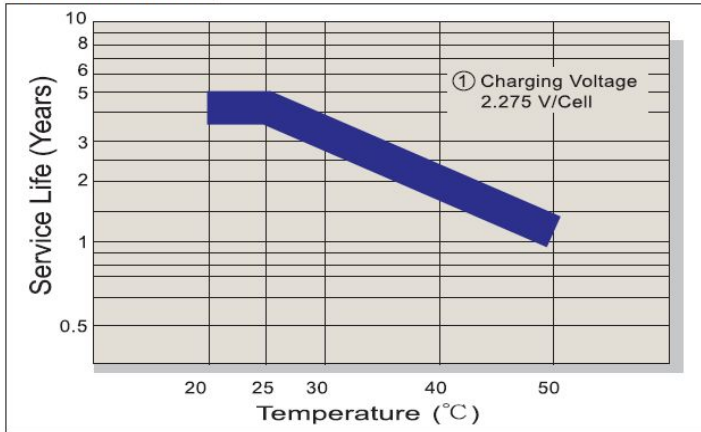

### Capacity Retention Characteristic

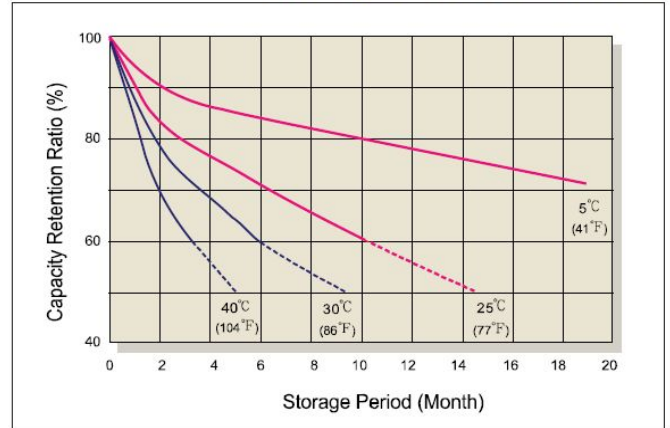

### Battery Voltage and Charge Time for Standby use

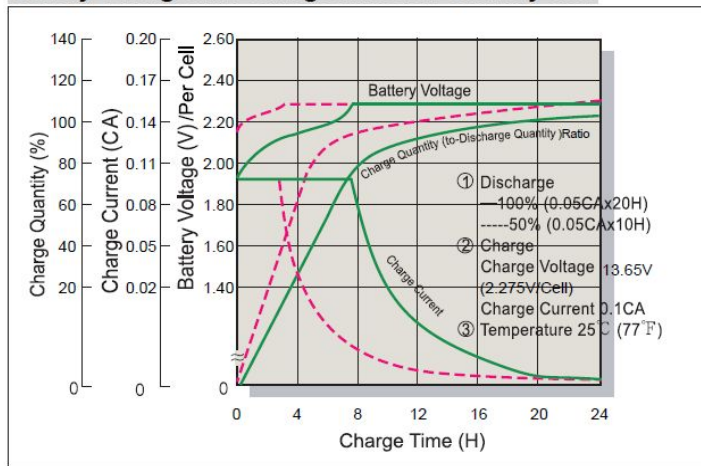

### Cycle Service Life

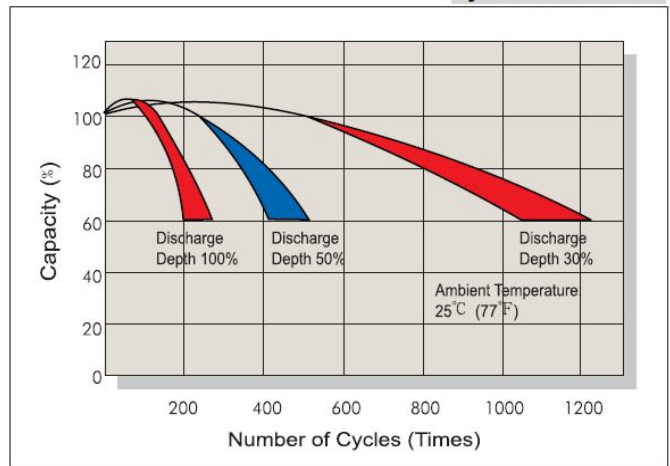

### Battery Voltage and Charge Time for Cycle Use

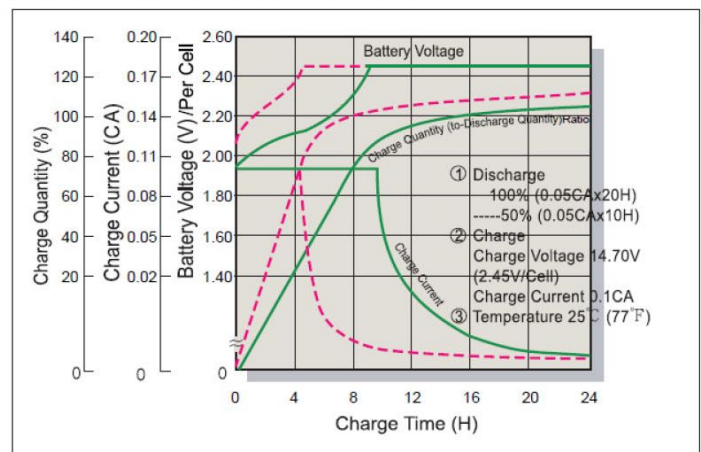

### Terminal Voltage (V) and Discharge Time

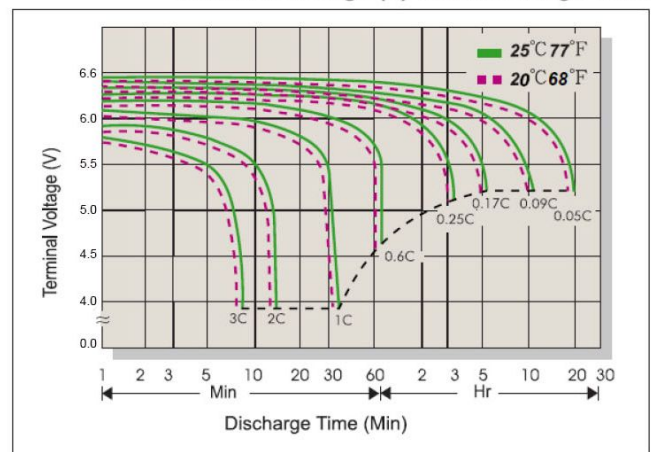

### Charging Procedures

Application	Charge Voltage(V/cell)			Max. Charge Current
	Temperature	Set Point	Allowable Range	
Cycle Use	25°C(77°F)	2.45	2.40~2.50	0.3C
Standby	25°C(77°F)	2.275	2.25~2.30	

### Discharge Current VS. Discharge Voltage

Final Discharge Voltage V/cell	1.75	1.70	1.65	1.60
Discharge Current (A)	0.2C > (A)	0.2C < (A)	0.5C < (A)	(A) > 1.0C

KaiYing Power Supply & Electrical Equip Co., Ltd.

Address: KaiYing Industrial Park, ChengXiang Town, Anxi, Quanzhou, Fujian China

Tel: 86-595-68782266 Fax: 86-0595-68782222

Website: [www.longwaybattery.com](http://www.longwaybattery.com) Email: [Sales@longwaybattery.com](mailto:Sales@longwaybattery.com)